

DuraPass Uninsulated Side-Hinged Garage Door Installation Instructions for residential double leaf side-hinged doors

Dec 2022 V1



- DuraPass double is a precision designed and manufactured product that requires the same attention to detail at installation.
- **The door is manufactured to a tolerance of $\pm 2\text{mm}$ in width or height.**
- **It must be installed to a tolerance of $\pm 1\text{mm}$ per metre or less, to ensure the doors operate and functions correctly.**
- We stipulate the use of a laser level when installing the door frame to ensure the required tolerances are achieved. Failure to do so will impact performance.
- The threshold is not suitable for vehicular or heavy wheeled item access.





This new GDS door has been designed for ease of operation, security and attractive appearance with minimal maintenance. Performance of the door will be impaired if it is installed incorrectly.

DuraPass double doors are designed to a fitting tolerance of ± 1 mm per metre or less. It is therefore imperative that you install the door frame level & square to ensure the doors' effective operations. We strongly recommend using a laser level to achieve optimum frame setting at the crucial stage of setting & securing the door frame. Failure to install the frame correctly to these tolerances will impact the doors' performance.

Read these instructions carefully before commencing the installation. Warranty is void if the door is not installed correctly according to these instructions.



WARNING! FRAGILE!

PRE-INSTALLATION CARE AND HANDLING

- The door must be handled with care at all times. Ensure the frame and door leaves are well protected and secured in transit to avoid any scratching or scuffing
- The doors length must be supported in its entirety during transport and handling
- The door must be stored on a flat **DRY** surface



WARNING!

Ensure that the area around the opening is strong enough to support the door.

GENERAL NOTES

Both one and two leaf doors are installed in the same manner.

Be sure all warning labels and tags are properly affixed to the door and that the home owner information is left with the purchaser. Ensure you demonstrate the safe and proper operation of the door to the homeowner/user at handover.

SAFETY EQUIPMENT

Goggles
Safety Shoes
Gloves



YOUR SAFETY FIRST!
Read this booklet carefully before installing your door

WHO SHOULD INSTALL THIS DOOR?

A minimum of two people must be available for fitting.



THE BEST INSTALLATION PERFORMANCE

The best installation performance is achieved when DuraPass side hinged garage doors are installed within suitably engineered openings (i.e. timber frames or steel box section) that provide flush and level supporting structures.

This ensures the integrity of the door frame that may not be fully achieved at installation if packing out is required. This will impact the quality of the door performance.

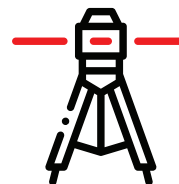

Please ensure your installation environment enables the frame to be installed level and square in all planes and use a laser level to confirm this.

FIXINGS

Fixings are not supplied with your door. The following are recommended:

For Masonry: M8 x 70mm Concrete Fixings, Washers & Plugs

x10

For Timber: M6 x 60mm Timber Screws & Washers

x10

TOOLS REQUIRED FOR INSTALLATION

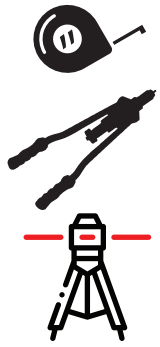

Tape Measure

Heavy Duty Rivet Gun
for Stainless Steel Rivets

Laser Level



Drill & Bits

Square

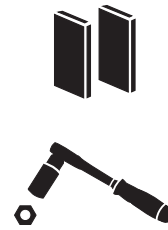

Packers

Ratchet Sockets

THE PACKED DOOR

The door is supplied as leaves and knocked down frame and packed as shown. The packaging includes a hardware kit with the following items:

- Black steel handle with fixings.
- Euro cylinder with internal thumb turn.
- 24 x stainless steel rivets (for securing the door leaves to the pre-punched frame through the hinges pre-fitted to the door leaves - 12 per leaf).
- Fixing hole covers.
- Handed door stays & fixings.
- Top and bottom shoot bolts for inactive leaf with 8 x 20mm Philips Head bolts & washers.



Ensure the frame and leaves are well protected and secured in transit to avoid any scratching or scuffing. Transit damage is not covered under warranty.

THE OPENING

The opening in which the door is to be fitted should be in a suitable condition. For stability and long service life, adequate preparation work is essential.

The opening must be formed from materials of adequate strength and all brick or concrete. Block work should ideally be a minimum of 15N/mm².

Aerated concrete is not recommended and hollow bricks/blocks should be suitably back-filled during opening construction to provide strength for the frame fixing bolts.

Where doors are to be installed into low density block work (7N/mm²) additional fixings may be required to ensure stability.

IMPORTANT: Openings must be plumb and square and the floor area within the arc swept by the door leaf must be level or slope down from the opening. The threshold must be flat/level and sound across the full width of the opening.

IMPORTANT: DuraPass door frame and door leaf components are manufactured to a tolerance of $\pm 2\text{mm}$ in width or height

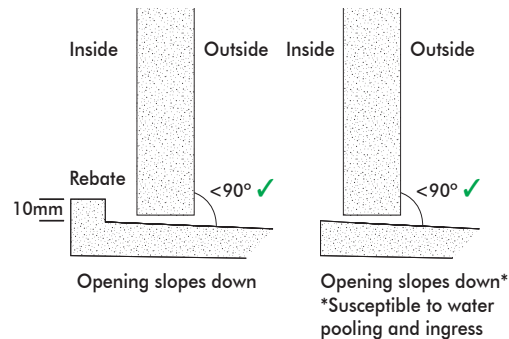
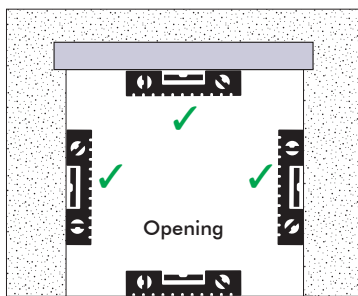

Outward opening leaf clearance

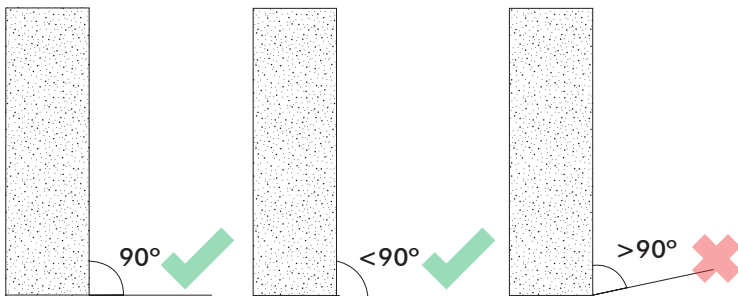

Drive level* Drive slopes down Drive slopes up
*Susceptible to water pooling and ingress

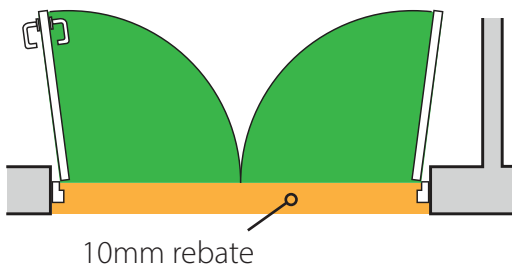
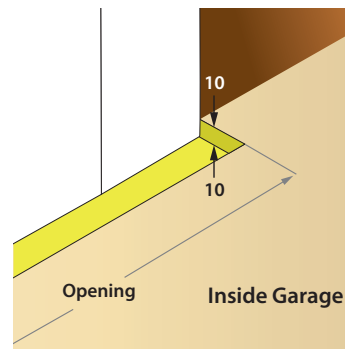

IMPORTANT: To help assist water draining away effectively from your door and prevent water ingress you must have a rebate (minimum 10mm) high behind the door threshold. If your floor is not rebated and not sloping down from the inner face of your door outwards, you will be susceptible to water ingress, as water will not be able to drain away effectively.

The pre-fitted threshold must be level and fully supported along its full length. **The threshold is not suitable for vehicular or heavy wheeled item access. This will distort the threshold and/or the Q-Lon seal.**



FIXING THE FRAME INTO THE OPENING

Position the frame in the opening.

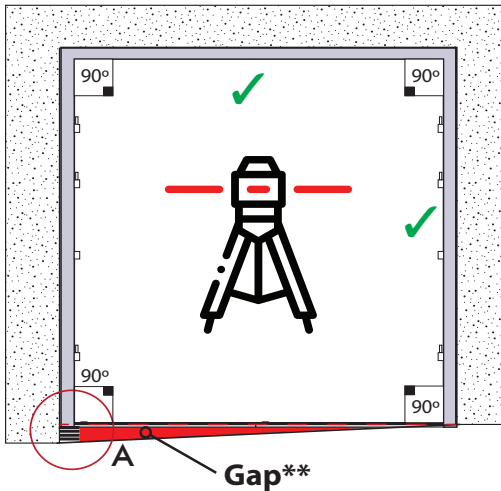

Check square and level with a laser level.

Ensure the frame legs are plumb. If the frame head and threshold are not level, use packers to raise one of the frame legs (A) until the header and threshold are level.

 **If the frame installation is incorrectly executed, performance will be significantly impaired, cause potential failure and void the warranty. If the frame is not level and square there will be light ingress.**

 ****Any gap created under the threshold must be filled and the threshold fully supported along its entire length. An unsupported threshold will distort and this will significantly impair performance.**

Check the diagonals to ensure all is square.

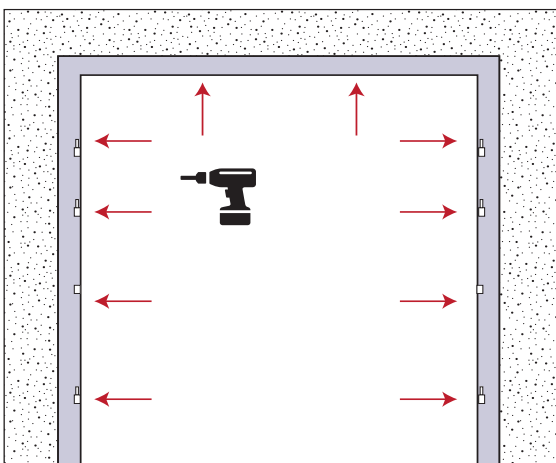

Remove the cover grommets from the frame legs and drill through into the opening block work. Fix the frame legs suitable fixings (see page 2). Do not refit the cover grommets in-case adjustment is required. Recheck the frame is plumb and square at all points.

The optimum sealing, latching and locking of your door is dependent on the proper installation of the door frame. **It must be level and square.** If the opening is out of true, packers should be used to bring the frame to level and square and ensure that the fixings do not distort or twist the frame when tightened. Distortion of the frame prevents good sealing, latching and locking.

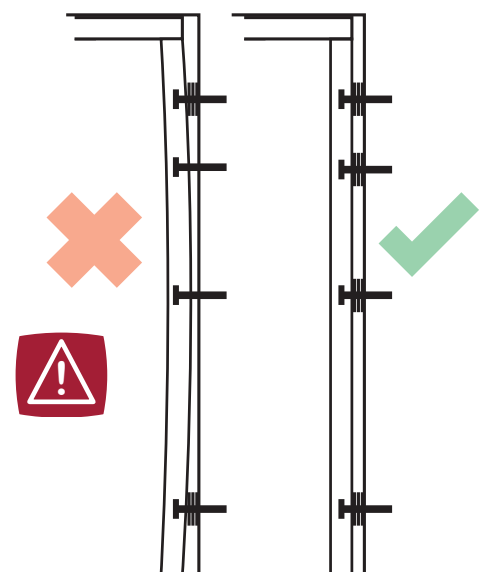
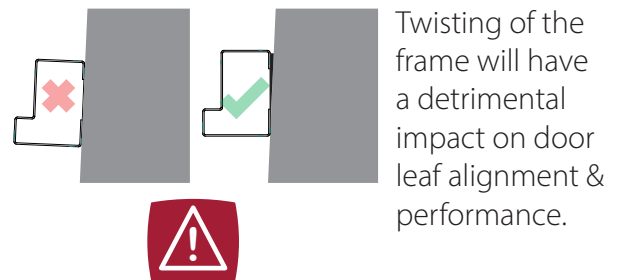
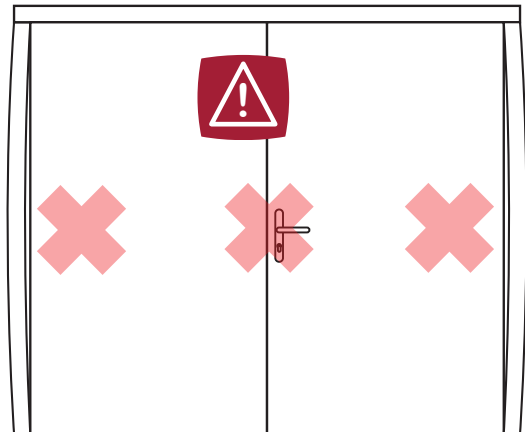

If the frame requires packers, ensure you use packers at each fixing point to prevent distortion of the frame.

FITTING THE DOOR LEAVES & THE FOURTH HINGE

Once the frame is secured in the opening, the door leaves can be attached to the frame - a 2 person job.

Each door leaf is supplied with four pre-fitted hinges.

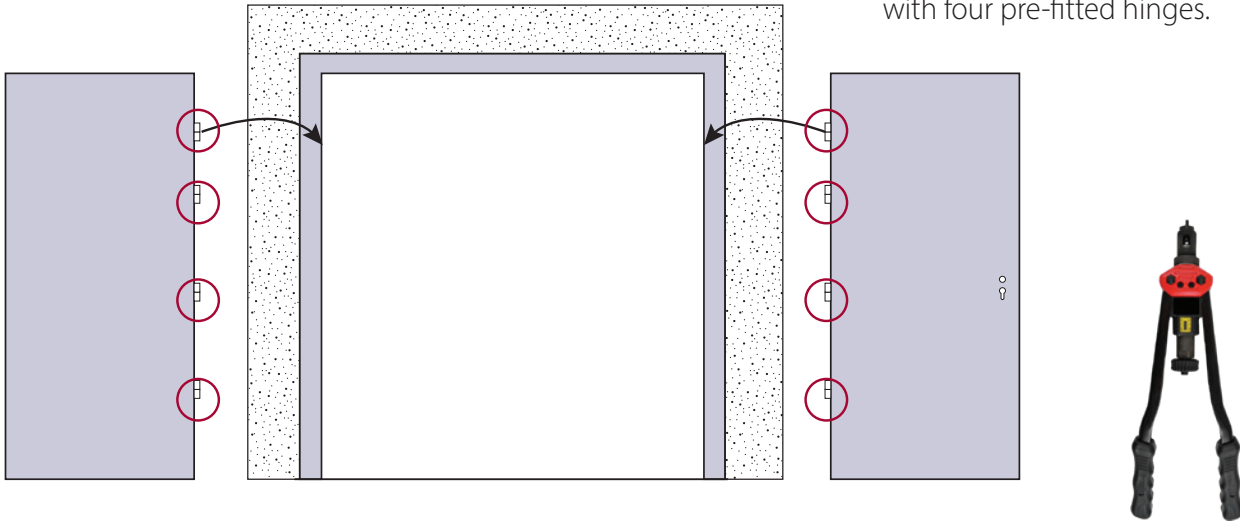

Lift the leaf into position aligning the hinges with punched holes on frame.

Secure the top hinge through the centre hole with 1 x stainless steel rivet.

Secure the bottom hinge in the same way.

This will be sufficient to hold the weight of the leaf to enable the insertion of the remaining 10 x rivets into each hinge.

Repeat for the opposite leaf.



The stainless steel rivets supplied must be used (they are more robust than standard rivets) and require a heavy duty rivet gun.



Fitting behind an opening. For the hinges to clear the side of the opening and to allow the door to open and lock out at 90°, a maximum overlap of 25mm of the frame on each side is possible - see dimension detail shown to the right.

Care must be taken to ensure the door does not strike the reveal when opening. Damage of this kind is not covered under warranty.

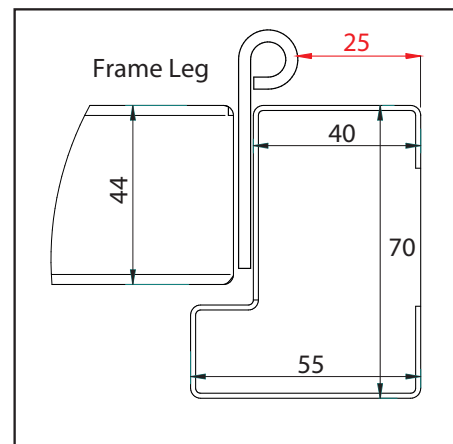

Door leaf alignment. If the door leaves do not align, the frame is not square and level - check and adjust as required to bring the leaves true.

Fit the cover grommets to the fixing holes.

FITTING THE DOOR HANDLE AND LOCK CYLINDER



Position the lock cylinder and secure with the bolt provided. **Do not fully tighten yet.**

Tighten the thumb turn cylinder after handle has been secured correctly.



Check the operation of the latches and locks and their engagement into the frame keeps.

Fit the gasket to the outer handle. Secure the handle using the bolts provided, ensuring these are on the inside face of the door.

FITTING THE STAYS

Doors stays are handed and have a sticker "Left Handed as viewed from inside" or "Right Handed as viewed from inside".



The door stay fixes into the frame head (4 x 20mm Philips nuts into pre-fitted nutserts) and the door leaf (4 x 20mm Philips nuts into pre-fitted nutserts).



Stay at 90° fixing point

There are two positions for attaching the arm to the door leaf:

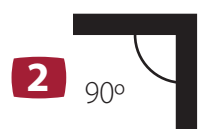
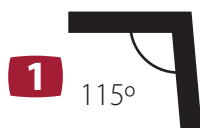
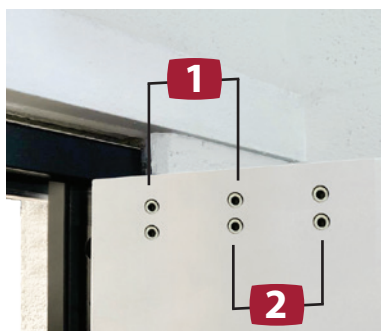

Fix the stay to position 1 for 115° hold open point

Fix the stay to position 2 for 90° hold open point



Door stays are designed to temporarily hold the door leaf open and not for extended periods. When a door leaf is open and exposed to the elements it acts like a "sail". Please exercise extreme caution when opening, closing and securing doors in windy conditions. Door stays are not designed for high wind applications (Damage of this nature is not covered under warranty).

INACTIVE LEAF SHOOT BOLTS

The inactive leaf top and bottom shoot bolts are supplied loose.

Fit to the pre-fitted nut-serts with the 8 x 20mm Philips Head bolts & washers supplied.



FINISHING

CLEAN AND DRY THE DOOR THOROUGHLY INSIDE AND OUT WITH A QUALITY CAR SHAMPOO TO REMOVE ANY GREASE, DUST AND METAL FRAGMENTS FROM THE DOOR (THESE MAY DISCOLOUR THE DOOR FINISH IF LEFT ON THE DOOR).

The door is now installed and should operate smoothly. The door is supplied with 3 keys for the lock and these, along with the fitting instructions should be given to the end-user on handover.

Quality Inspection.

This check is as the recommended standard from the Door & Hardware Federation (DHF). The quality check should be carried out in natural daylight, not direct sunlight. Stand at a distance of 3 metres from the door to view the overall appearance. The door is acceptable if, taking into account the facts below, none of the following is readily visible on the face of the door:

- marks or distortion associated with the manufacturing process
- minor indentations, marks or scuffs on the surface
- paint or stain blemishes

Operation and future adjustment.

The door should only be opened using the active leaf first, using the handle with stay fully engaged. The inactive leaf should always be opened second to the fully open position with stay fully engaged.. "Throwing" the leaf open will result in potential damage to the door leaf and stays. The inactive leaf must always be secured with the top and bottom shoot bolts located to ensure correct alignment of the door leaf and a secure closure.

A light spray oil should periodically be applied to the hinges, lock and door stay mechanism.

INSTALLED BY:

DATE:

***SERVICE CONTACT NUMBER:**

* To ensure the validity of this product's warranty, the door must have as a minimum a biennial service (every 2 years) to ensure its safe operation is maintained.



Call:
Northern Ireland: 028 2565 5555
UK 0870 242 3 242
Republic of Ireland 1850 510 510

Email: info@garagedoorsystems.co.uk
Web: www.garagedoorsystems.co.uk

Garage Door
Systems Limited,
Wakehurst Ind.
Est., Ballymena,
BT42 3AZ

Garage Door Systems operates a policy of continuous product development and reserves the right to alter specifications to product design features, product functionality, other product specifications and product manufacture without notification.

All specifications are correct at time of publication, errors and omissions excepted.

Date 12/22 Issue 1. Colours shown are for guide purposes only and are limited by the printing process.